

LEGEE-688

Vacuum-Mop 4 in 1 Robot

FastBrush + LEGEE®

User Manual



iENA

Winner of Silver Medal at iENA
Germany Exhibition of inventions



◎ Important Safety Precautions

Please read all instructions before using.

The device can be used by children aged from 8 and above and persons with reduced physical, sensory or mental capabilities or lack of experience and knowledge if they have been given supervision or instruction concerning use of the device in a safe way and understand the hazards involved. Children shall not play with the device. Cleaning and user maintenance shall not be made by children without supervision.

Warning:

Do not expose LEGEE or its accessories' electronics parts. Should the product become damaged or need replacing at any time, all service or repairs must be carried out by an authorized service agent. Please ensure electrical input voltage is compatible with the charging station.

- Follow all instructions and warnings.
- After reading this manual, please keep it in an easily accessible location.
- Please clean seven sensors and side brush before use.
- Place the cleaning cloth under the device flatly before use.
- Only fill the water tank with water or diluted LEGEE detergent, other detergents are not allowed.
- Avoid using the device on greasy surface.
- Clear electrical cords, body parts and curtains away when using the device.
- Keep the device and accessories away from children.
- Keep the device in dry and cool place, away from direct sunlight, naked flames, heat, humidity, water and any other liquids.
- Do not store the device near oil, combustible spray or flammable materials.
- Product operating temperatures: 0°C ~40°C (32°F ~104°F)
- Product storage temperatures: -10°C ~50°C (14°F ~122°F)

◎ Safety Warnings

- Connect the power adapter only to a power source that matches the specifications. The power adapter is designed for connection to hazardous electrical voltages. Do not attempt to repair the adapter. Replace the whole unit if it is damaged or exposed to high moisture. Consult local HOBOT dealer for help and maintenance.
- Make sure the device, power adapter and charging station are not trapped under heavy objects.

- Allow adequate ventilation around the device, power adapter and charging station. Do not cover them with objects.
- Do not use the device, power adapter and charging station in a strong magnetic field, humid or high heat environment.
- Please use the original power adapter, battery and charging station that came with the device. Use any third-party components may result in damage, malfunction and/or danger.
- Battery can explode, catch fire, and/or cause burns if disassembled, crushed, cut, punctured, short-circuited, incinerated, recharged (disposable cells), or exposed to water, fire, or temperatures above 60°C (140°F).
- If the device is not in use for a long period of time, store it in a dry and safe location. The battery will need to be charged every 3 months to maintain battery life.
- Never operate this device if the cord or power adapter is damaged. Ensure the power cord is not stretched or exposed to sharp object or edges.
- Do not use the device if any part or any accessory is damaged or defective.
- Before using the device, remove any fragile objects from the floor e.g. glass pieces or any other objects that could block or damage the device.
- Do not leave any fragile objects on the side of the tables, cabinets etc. where the device could bump into and cause them to fall.
- Switch off the power and disconnect the power plug before dismantling, assembling or cleaning the device, power adapter and charging station.
- Do not clean the unit by spraying it or immersing it in water. The device is not waterproof.
- Any service other than regular cleaning should be only performed by an authorized service representative.
- Contact your local waste management authority to follow local disposal regulations and never dispose the device and rechargeable batteries with normal household waste.

©Copyright & Trademarks

Copyright © 2019 by HOBOT® Technology Inc. All rights reserved.

No part of this publication may be reproduced, transmitted, transcribed, stored in a retrieval system or translated into any language or computer language, in any form or by any means, electronic, mechanical, magnetic, optical, chemical, manual or otherwise, without the prior written permission of this company.

All other logos, products, or company names mentioned in this manual may be the registered trademarks or copyrights of their respective companies, and are used for informational purposes only.

©Disclaimer

HOBOT Technology Inc. makes no claims or warranties, either expressed or implied, with respect to the contents hereof and specifically disclaims any warranties, tradability or suitability for any particular purpose. Furthermore, HOBOT Technology Inc. reserves the right to revise this publication and to make changes from time to time in the contents hereof without obligation of this company to provide notification of such revisions or changes. The user should follow the instructions provided in this user manual, but is ultimately responsible for assessing placement and safety when using this cleaning tool.

©Laser Safty

The laser distance sensor of this product meets the standards for Class I Laser Products in IEC 60825-1:2014 and will not generate hazardous laser radiation.

©Limited Warranty

If there are defects in your LEGEE due to faulty materials, poor workmanship, or malfunction within the warranty period from the date of purchase or delivery, please immediately contact a local retailer or local authorized dealer for repairs or replacement. This limited warranty does not cover:

- Normal wear and tear, including parts that might wear out over time (e.g. side brush, cleaning cloth, caterpillar belt, spray nozzle and filter, etc.)
- Reduction in battery runtime due to battery age or use, as the life of the battery (1 year) and number of times the device is used.
- Transit, delivery or accidental damage or misuse and abuse that is not in accordance with the instructions.
- Faults or damage caused by:
 - Negligent use, misuse, abuse or careless operation of the device.
 - Use of the device which is not in accordance with this manual.
 - Use of anything other than normal domestic household purposes in the country in which it was purchased.
 - Use of parts not assembled or installed in accordance with this instruction.
 - Use of any unauthorized parts and accessories. Please contact a local retailer or local authorized dealer for spares and accessories.
 - Faulty assembly or installation.
 - Repairs or alterations carried out by parties other than HOBOT authorized dealer.

◎Product Features

Exclusive Patent License: FastBrush 4-Stage Cleaning

FastBrush 4-stage cleaning allows LEGEE to complete vacuum, dry mopping, water spray and wet mopping in one take.



The powerful vacuum can easily pick up small particles such as dust and hair, then mops the surface with the front cleaning cloth at 600 times/min*. which is powered by the reciprocating moving mechanism to imitates the human behavior to remove the stubborn dust off the floor. Followed by the smart water spray that is equipped with temperature sensor that sprays just enough water to dissolve the stains but not leaving the water residue behind. The rear cleaning cloth which also shares the same movement with the front cleaning cloth finally finishes cleaning by absorbing the dissolved stains and polishing the floor.

*Under standard mode.

Three Cleaning Routes



Zigzag Cleaning Route

LEGEE will travel in zigzag route to clean the floor, when complete, LEGEE will proceed HOME mode.



Wall-Follow Cleaning Route

LEGEE will travel along the wall to clean the edge of the floor, when complete, LEGEE will proceed HOME mode.



AUTO Cleaning Route

= Zigzag + Wall-Follow Cleaning Routes



LEGEE will divide the area to 4.4×4.4 meter² and proceed Zigzag Cleaning accordingly, then finish up with Wall-Follow Cleaning mode. When complete, LEGEE will proceed HOME mode.

Talent Clean

There are 7 Talent Clean modes: Standard, Strong, ECO, Kitchen, Dry, Pet and Polish. 1 customized mode for your desire settings exploration to serve any special needs.

Talent Clean



Mode	Introduction
 Kitchen	HOBOT exclusive patent. Specialized to clean the stubborn stains we often left behind on the kitchen floor. LEGEE will first divide the area to 1.5m×1.5m and spray generous amount of water to dissolve the stains, then go back to mop and absorb the dissolved stains, the floor will be world-class clean!
 Pet	Cleaning pets' hair haven't been easier! Under pet mode, the vacuum power is increased to collect light hairs. Also, the increased water spray volume and higher mopping frequency can remove pawprints or stains on the floor.
 Polish	LEGEE will clean the floor by increasing water spray volume and mopping frequency while lowering moving speed to remove old dirt and water marks on the floor, your floor will soon be restored to bright and shine!

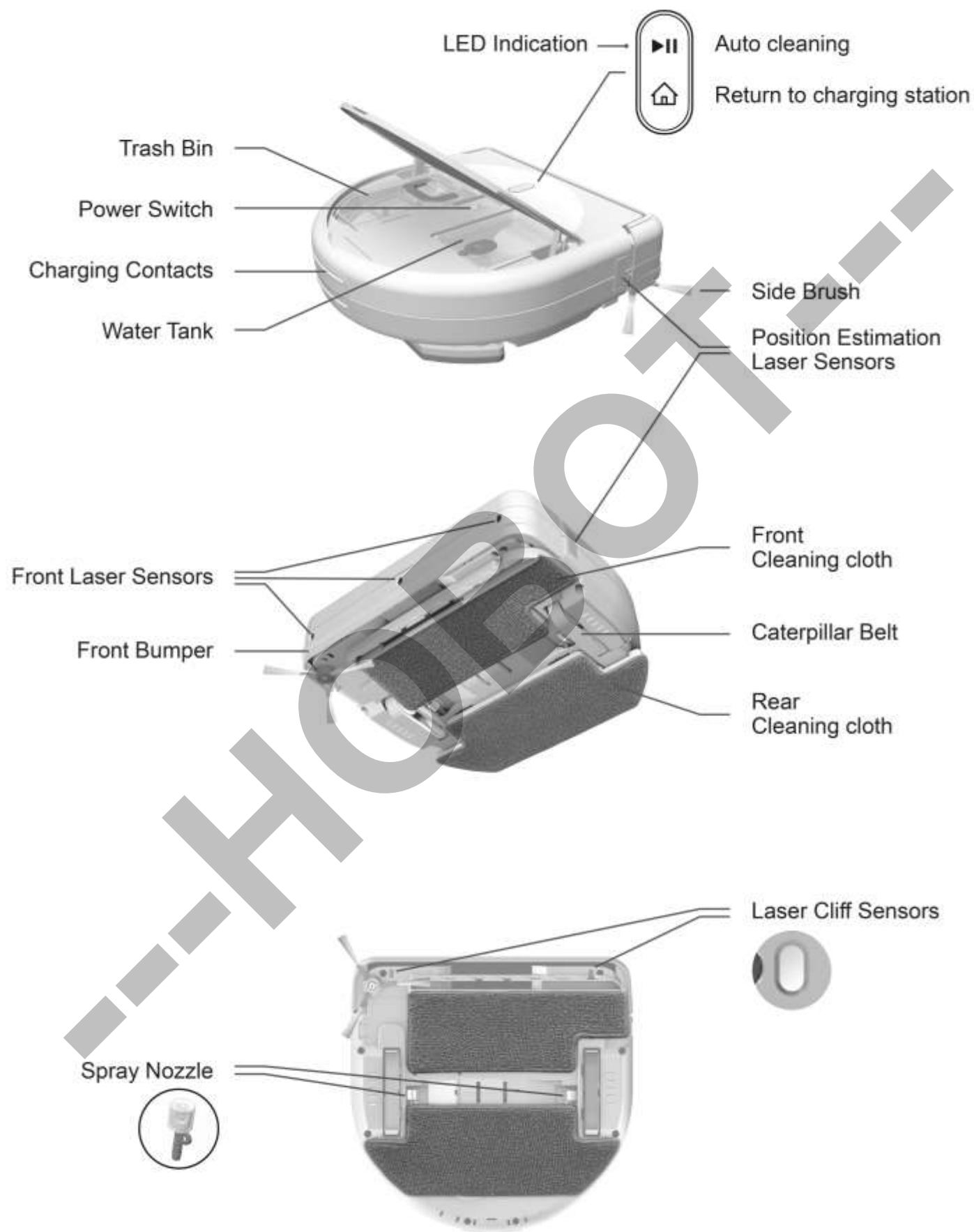

◎ Getting Ready

1. Install Charging Station

- Step 1. Place the charging station against a wall on hard surface flooring to prevent sliding during docking.
- Step 2. Ensure that there are no objects at least 1.5 meter in front and 1.5 meter to the right and left of the charging station.

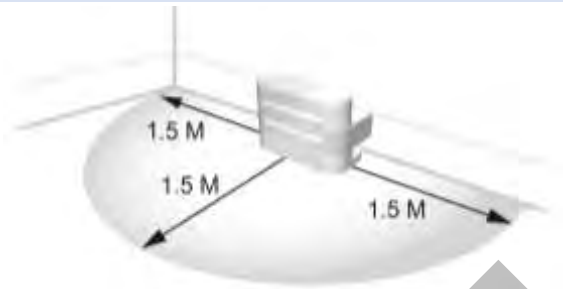

2. Charging your LEGEE

- Step 1. Plug power adapter into the charging station.
- Step 2. Place the round end of the robot against the metal contacts on the station. Before the first time of use, fully charge the battery for at least 4 hours until green light ON.

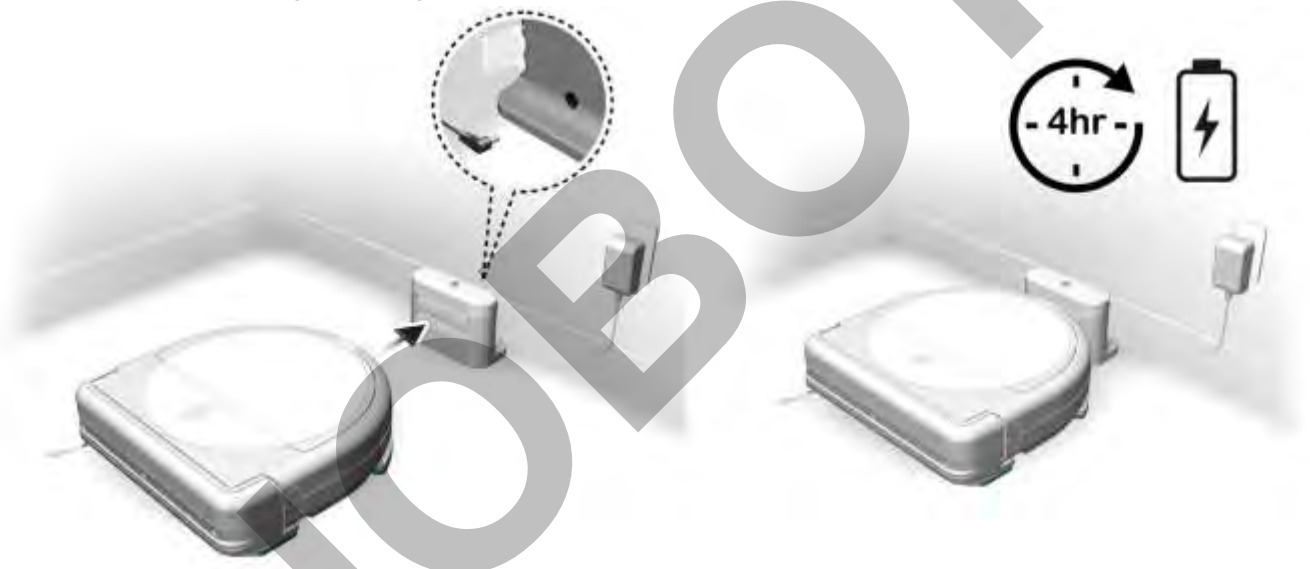

3. Attach / Change Cleaning Cloth

Attach the cleaning cloth to the device flatly. (as indicated by the dotted line)

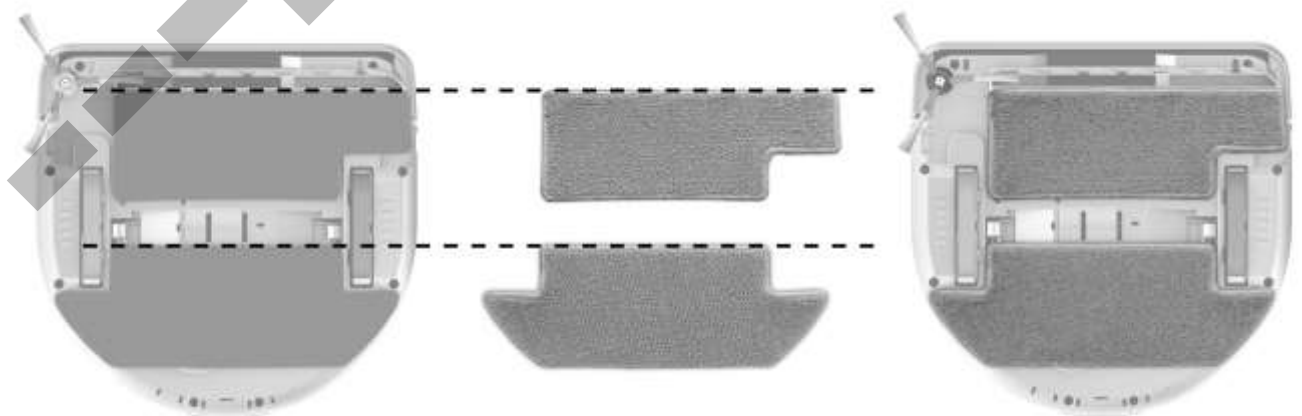

4. Install Side Brush

Press the side brush to the device to install until hearing the click sound.



5. Fill Water/Detergent

Fill water or LEGEE detergent to the water tank by using the supplied bottle and seal the water tank with the plug after filling.



6. Start/Stop Cleaning

Step 1. Start cleaning: Lift open the cover and press down the power switch, then close the cover and press  on the device or on the remote control or App. (Make the front bumper face to a flat wall if it doesn't start cleaning from the charging station.)

Step 2. Pause cleaning: Press  on the device or remote control.

Step 3. Stop cleaning: Press  on the remote control.



7. Take off the damp cleaning cloth

Please take off the damp cleaning cloth after cleaning to avoid damaging the floor after long contacting.

App Instructions

LEGEE-688 can be controlled by both the equipped remote control and HOBOT LEGEE App through Wi-Fi®.

1. Download and Install HOBOT LEGEE App



* **Please read and agree to our Terms of Service.**

- LEGEE does not support 5G Wi-Fi connection.
- Please make sure LEGEE and the smartphone are both under same Wi-Fi network with consistent Wi-Fi coverage.
- Please turn on Wi-Fi function on your smartphone and connect.

2. Start Cleaning with HOBOT LEGEE-688 App

Step 1. Lift open the cover and press down the power switch.









Step 2. Tap any Talent Clean mode.

Step 3. Tap  to proceed.

Step 4. Tap  to start cleaning. There will be Real Time Map to show the cleaned area simultaneously as LEGEE cleans.



◎Remote Control

Buttons	Action
	Spray Water Once
	Dry/Wet Mopping
	Manually Control
	Stop Cleaning
	Start Talent Clean: Kitchen Mode
	Vacuum Power: 5 levels
	Return Charging Station
	Auto Cleaning Route: Start/Pause
	Wall-follow Cleaning Route

◎LED Indication

Situation	LED Indication
Dry mopping	White light on
Wet mopping	Blue light on
Spraying water	White and blue light flashing
Low battery	Orange light flashing
Searching for charging station	Orange and blue light flashing
Battery charging	Orange light on
Battery charged full	Green light on
Warning	Pink light on
Pairing	White light flashing
Hardware failure code (contact your local dealers for help)	Blue and red light flashing

◎Cleaning & Maintenance

1. Clean 7 Laser Sensors

- Press the right side of the bumper and then pull the left side of the bumper out to detached it from LEGEE.

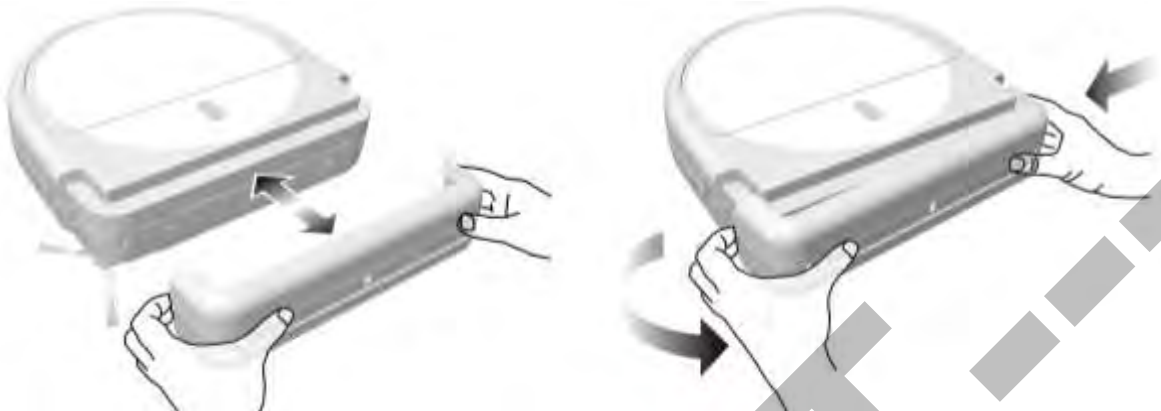

- Use a clean, dry soft cloth or to clean 7 laser sensors.

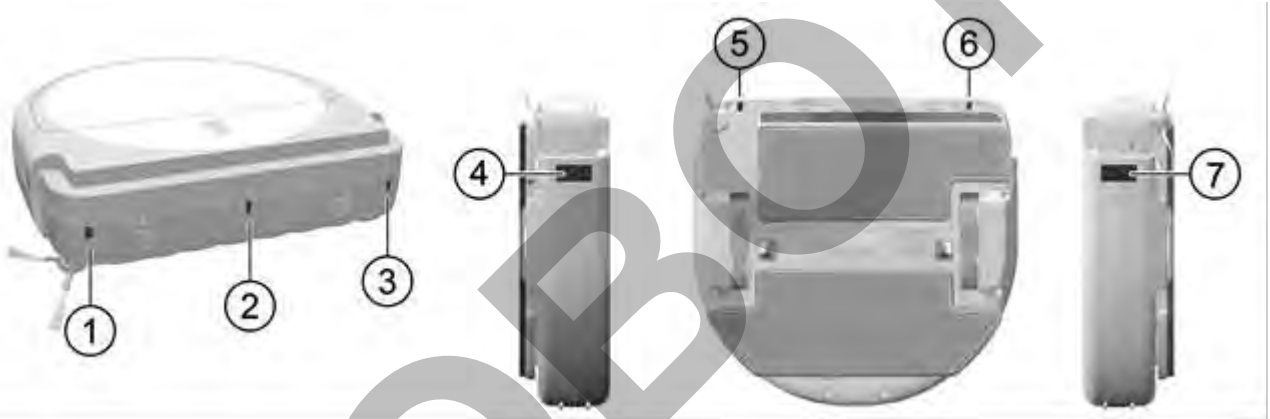

Care Frequency: Before each use or follow App's reminder.

2. Empty Trash Bin

- Take out the trash bin by lifting the top handle and open the trash bin to remove the dust.

Care Frequency: After each use or follow App's reminder.



3. Clean Screen Filter

- Gently shake off the fine dust from the screen filter. Please rinse the screen filter if needed.

Care Frequency: After each use.



4. Clean HEPA Filter

- Gently shake off the fine dust from the HEPA filter.
- Please don't wash the HEPA filter.
- Please replace HEPA filter if it is too dirty.

Care Frequency: After each use.

Please contact a local retailer or local authorized dealer for additional consumable spare parts.



5. Cleaning Side Brush

Pull off the side brush, then gently rub the side brush with warm water to clean the dirt off and restore it to its original shape. Reinstall the side brush.

Care Frequency: After each use.

Please contact a local retailer or local authorized dealer for additional consumable spare parts.

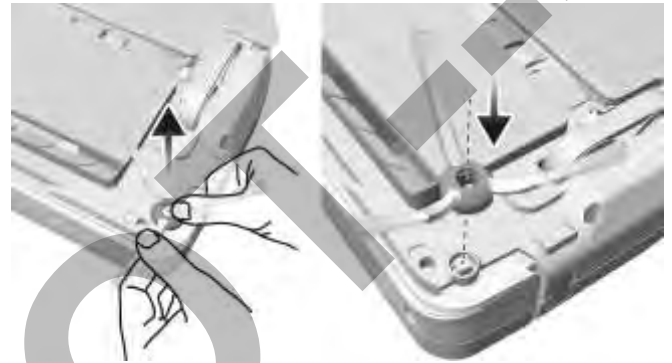

6. Clean Cleaning Cloth Care Instructions

Wash with detergent and dry flat to prevent odor.

- Washing under 40°C (104°F).
- Do not bleach.
- Do not tumble-dry.
- Do not iron.
- Do not dry clean.

Care Frequency: After each use.

Please contact a local retailer or local authorized dealer for additional consumable spare parts.



7. Replace Spraying Nozzle

Use a small screwdriver to remove the screw and nozzle. Replace with new nozzle and screw it back.

Care Frequency: When nozzle is clogged and cannot spray water.

Please contact a local retailer or local authorized dealer for additional consumable spare parts.

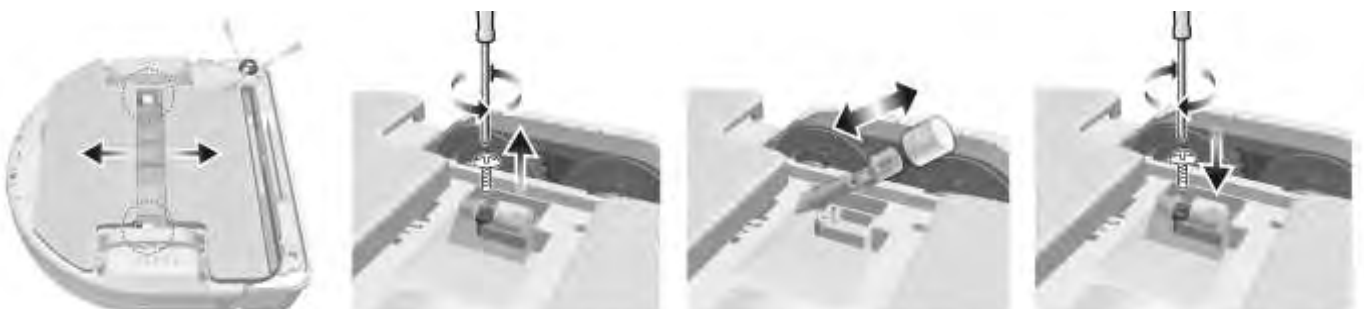

☉Frequently Asked Questions (FAQ)

Case	Solution
1. Can't be switched on	Check if the battery has been charged.
2. LEGEE cannot return to the charging station	Check if the adapter has been properly connected to the charging station and it has been plugged into the power socket. Clear the objects around the charging station and clean the sensors with clean dry cloth.
3. Poor contact with charge contacts	Please switch off the power and remove the power source from the charging station. Clean all charging contacts by using a clean cloth with rubbing alcohol to remove oxide.
4. Avoid charging interruption	It is advised to keep LEGEE switched on when charging, LEGEE will be able to return to the charging station automatically in case LEGEE is slightly moved.
5. The power consumption if leave LEGEE standby after fully charged	The power consumption is very low when LEGEE is standing by, letting LEGEE stay connected to the charging station can help to maintain the battery's best performance.
6. The cleaning result is less satisfying	Switch off power, then clean or change the side brush, the dust box, HEPA filter and the cleaning cloth.
7. Works/moves abnormally	Switch off power, clean the side brush then clean 7 sensors and windows on the bumper. Also check if the bumper is properly installed.
8. The side brush does not spin	Switch off power, then check if the side brush is jammed. Clean the side brush and then reinstall it.
9. LEGEE does not spray water	Switch off power, check if spraying nozzle has been installed properly.
10. Testing spray nozzles	Press  on the remote control will make LEGEE to spray once. If LEGEE does not spray water, please change the spray nozzles.
11. The height limit of carpet	Any object that is taller than 3 mm height will be considered as an obstacle which LEGEE will not climb over.
12. Remote control does not work	Check if LEGEE has been switched ON and not under low battery status, LEGEE won't be able to follow the commend except return to charging station and manual controls. Please aim the remote control to LEGEE's top panel. Please replace the batteries in the remote control and try again.
13. How to make LEGEE to clean more efficiently	Please clear the clutter, rugs, power cords, draperies before cleaning.
14. Red and blue light flashing	Hardware failure, please contact your local dealers for help.
15. Unable to link to App/LEGEE when pairing	Please restart LEGEE and App. a) Weak Wi-Fi signal, please make sure LEGEE and the smartphone are both in the same area with consistent Wi-Fi coverage.

	<ul style="list-style-type: none"> b) Please update HOBOT LEGEE App and try again. c) Wrong password. d) LEGEE does not support 5G Wi-Fi connection, please use 2.4G Wi-Fi.
16. Unable to link to App/LEGEE	<p>Please restart LEGEE and App.</p> <ul style="list-style-type: none"> a) Weak Wi-Fi signal, please make sure LEGEE and the smartphone are both under consistent Wi-Fi coverage. b) Please update HOBOT LEGEE App and try again. c) If LEGEE has been moved to a different wireless network, please re-pair LEGEE with the App before use.
17. LEGEE does not clean as scheduled	LEGEE must be switched on and not under low battery status to proceed scheduled cleaning.

If any problems occur and this manual cannot provide the solution you need, please contact a local retailer or local authorized dealer.

© Specifications

Model No	LEGEE-688
WiFi	802.11b/g/n
Battery	Li-Ion 2750 mAh
Dimensions	340 mm × 330mm × 95mm (LWH) (13.4 in × 13.0 in × 3.7 in)
Charging Station	
Input Voltage	100~240 V, 50~60 Hz
Adapter Output	19V/1A, 19W

© Product and Accessories

LEGEE-688	Charging station
AC adapter	Remote control
Water bottle	User manual
Cleaning cloth	Side brush
Spray nozzles	HEPA filter



HOBOT Technology Inc.
www.hobot.com.tw